

On-Premises 80-lb Hardmount Washer-Extractor



Maximized throughput, minimized costs. That's what busy on-premises laundries demand. Huebsch® hardmount washer-extractors deliver those results, while producing exceptional finished wash quality. In addition, their durability ensures the machines will be consistent laundry performers for years to come.

Strength

Our computer-optimized, heavy-duty frame is lighter, lasts longer, balances loads more efficiently, and reduces sound and vibration levels. Huebsch washer-extractors also boast two triple-lip seals and an excluder-face seal for seven layers of bearing protection.

Power

Proprietary inverter-drive technology provides smooth, reliable power, saving you 33% on electricity while maximizing cleaning power. Our inverter also exerts 200 G-Force extraction to remove more moisture from loads and reduce drying time.

Performance

Available in a variety of capacities, including 20 lb, 30 lb, 40 lb, 60 lb, 80 lb and 100 lb capacities, Huebsch cabinet hardmount washer-extractors also offer a variety of control options to match your operation's unique requirements.



Galaxy™ with eBoost™

Customize your washing power with the ability to choose between three water levels while eliminating wasted water with advanced leak detection. PC programming, audit data retrieval and advanced diagnostics save time, while 200 G-Force extraction speeds reduce drying time and utility consumption.

On-Premises 80-lb Hardmount Washer-Extractor Specifications

MODEL		HCT080	
CONTROL OPTION		Galaxy	
CAPACITY - lb (kg)		80 (36)	
OVERALL WIDTH - in (mm)		41 1/2 (1054)	
*OVERALL DEPTH - in (mm)		48 1/2 (1234)	
OVERALL HEIGHT - in (mm)		56 3/16 (1426)	
CYLINDER DIAMETER - in (mm)		36 (916)	
CYLINDER DEPTH - in (mm)		22 (559)	
CYLINDER VOLUME - cu. ft. (liters)		12.4 (354)	
DOOR OPENING SIZE - in (mm)		18 1/2 (470)	
DOOR BOTTOM TO FLOOR - in (mm)		17 15/16 (455)	
WATER INLET CONNECTION - in (mm)		2 x 3/4 (19)	
DRAIN DIAMETER - in (mm)		1 x 3 (76)	
DRAIN HEIGHT TO FLOOR - in (mm)		5 3/4 (145)	
MOTOR POWER CONSUMPTION - hp (kw)		5 (3.7)	
TOTAL # OF SPEEDS		6, 9	
CYLINDER SPEEDS - RPM (G-FORCE)	Gentle	28 (0.4)	
	Wash	39 (.8)	
	Distribution	70 (2.5)	
	Very Low	230 (27)	
	Low	396 (80)	
	Medium	443 (100)	
	** High	495 (120)	
	**Very High	542 (150)	
	**Ultra High	626 (200)	
*** VOLTAGE/ CIRCUIT BREAKER - FLA	X	200-208/220- 240/50/60/1/3	15-12 (1 Ph) 15-8 (3 Ph)
	N	440-480/50/60/3	15-5
SHIPPING DIMENSIONS APPROX. - in (mm)	Width	44 (1118)	
	Depth	54 1/2 (1384)	
	Height	58 5/8 (1488)	
NET WEIGHT - lb (kg)		1210 (549)	
SHIPPING WEIGHT - lb (kg)		1260 (572)	
****AGENCY APPROVALS		c UL _{US}	

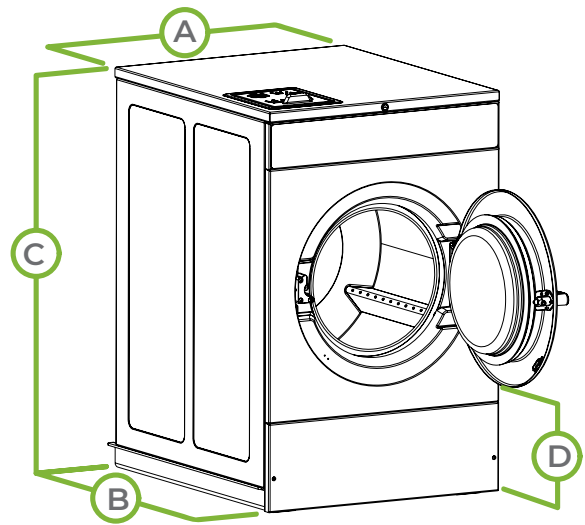

MODEL	HCT080
A. OVERALL WIDTH - in (mm)	41 1/2 (1054)
B. *OVERALL DEPTH - in (mm)	48 1/2 (1234)
C. OVERALL HEIGHT - in (mm)	56 3/16 (1426)
D. DOOR BOTTOM TO FLOOR - in (mm)	17 15/16 (455)

*Overall depth includes vacuum breaker to door handle.

**High, Very High, and Ultra High Spin Speeds are available on the Galaxy 400 models only.

***Circuit breaker and amp draw data shown are for models without electric heat. Consult factory for other configurations. Manufacturer strongly recommends using a circuit breaker instead of fuses. Use 3-pole circuit breakers for 3-phase machines.

****Agency approvals may vary depending on configuration. Consult factory for details. Steam connection requires 1/2" N.P.T.

For the most accurate information, the installation guide should be used for all design and construction purposes. Due to continuous product improvements, design and specifications subject to change without notice. The quality management systems at Alliance Laundry Systems are registered to ISO 9001.